

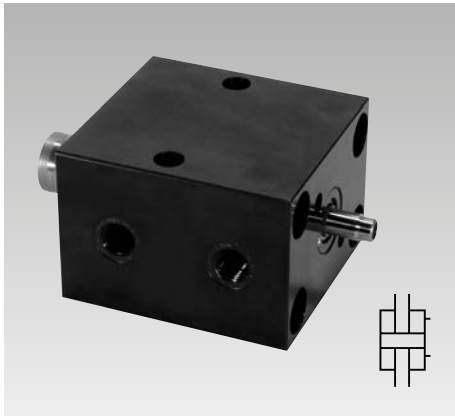

Block Cylinders

double acting, with extended piston rod for position monitoring,
 max. operating pressure 500 bar



Application

Block cylinders with extended piston rods are used if one or several piston positions have to be controlled. Especially if

- standard inductive proximity switches should be used.
- the piston positions have to be adjusted on the spot.
- control has to be effected at the cylinder bottom due to space restrictions

Description

The piston is equipped with a rod of diameter 10 mm that protrudes at the cylinder bottom. At this rod the customer can fix a control cam that is used to operate any limit switch or sensor.

As an accessory a complete position monitoring system is available. This unit contains a control cam as well as two inductive proximity switches. The switches can be displaced in the housing. The housing will be screwed on at the cylinder bottom.

Material

Cylinder body: high alloy steel,
 black oxide

Piston: case-hardening steel, hardened
 Sealings: FKM

Maximum operating temperature

Maximum admissible environmental and cylinder temperature (without accessory): 150 °C.
 When using accessories, pay attention to the maximum admissible environmental temperature. Especially for limit switches or sensors.

Important notes!

Tolerances, further operating conditions, and other data see data sheet A 0.100.

Advantages

- 8 sizes each with 2 stroke lengths available
- Compact block design
- Many fixing possibilities
- Many connecting possibilities
- Operating temperature up to 150 °C due to standard FKM seals
- Maintenance free
- Complete position monitoring available as accessory
- Position monitoring easily screwable
- Adjustable switching points
- Standard inductive proximity switches with external thread M8x1 can be used
- Inductive proximity switches up to 120 °C available

Fixing possibilities

Broad side with 2 cross holes

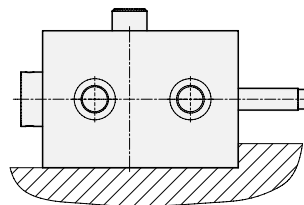

Cylinders must be backed up for operating pressures exceeding 160 bar.

Rod side with 4 longitudinal holes

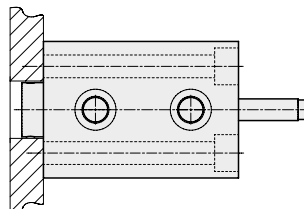

Accessories

- Contact bolts (see accessories)
- Position monitoring (see page 4)

Available variants

- Stroke reduction by distance bushing
- Keyway at the broad side of the body to support the body
- Internal thread to fix the body at the bottom or front side (instead of longitudinal holes)

Hydraulic connecting possibilities

Fitting connection

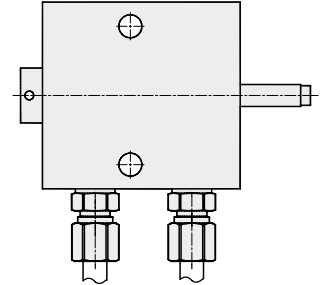

Flange-type version with O-ring sealing

• Broad side with 2 cross holes

Version K - from 20 to 40 mm stroke

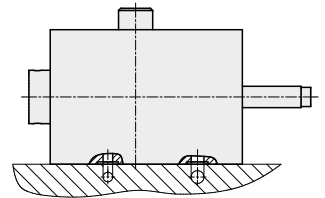

• Broad side with 4 cross holes

Version L - from 50 mm stroke

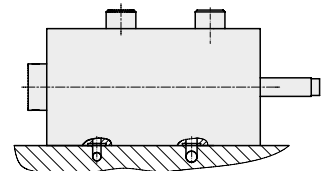

• Rod side with 4 longitudinal holes

Version S

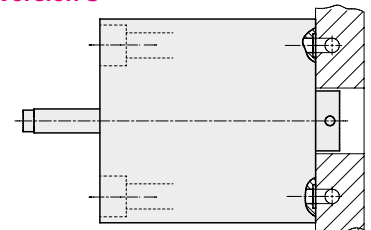

• Bottom side with 4 longitudinal holes

Version B

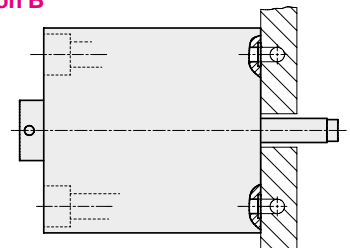

Dimensions

Pipe thread

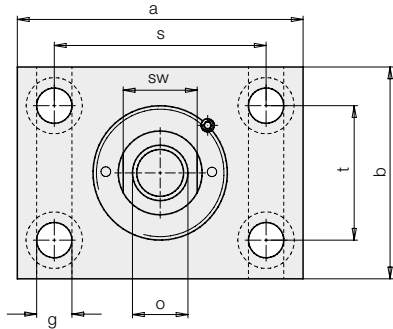
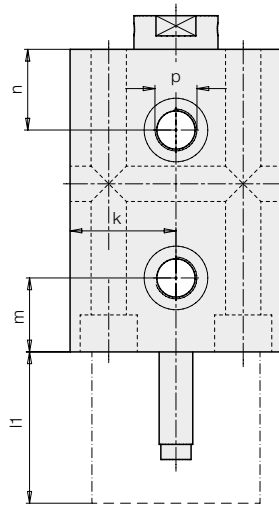
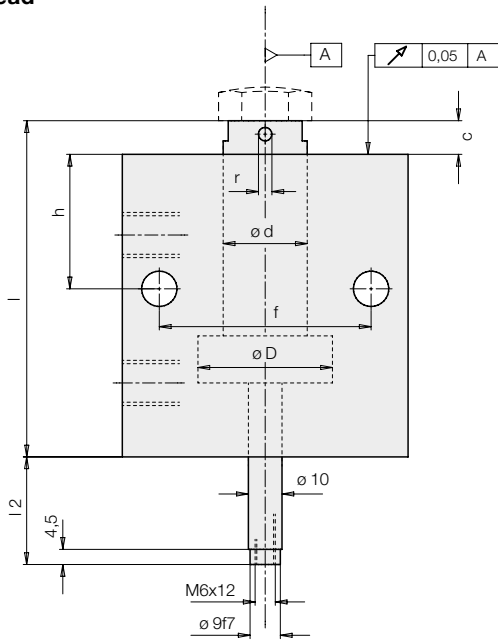

Version of the piston rod

Piston Ø
25 - 32 mm

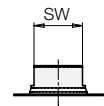

Piston Ø
40 - 125 mm

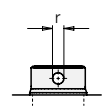

Flange-type version with O-ring sealing

Version K

Broad side with 2 cross holes from 20 to 40 mm stroke

Version L

Broad side with 4 cross holes from 50 mm stroke

Version S

Rod side with 4 longitudinal holes

Version B

Bottom side with 4 longitudinal holes

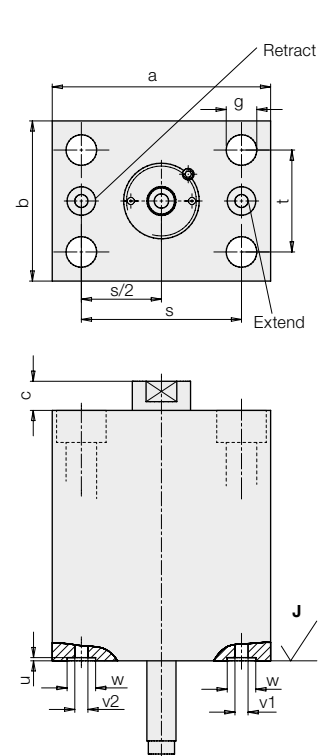
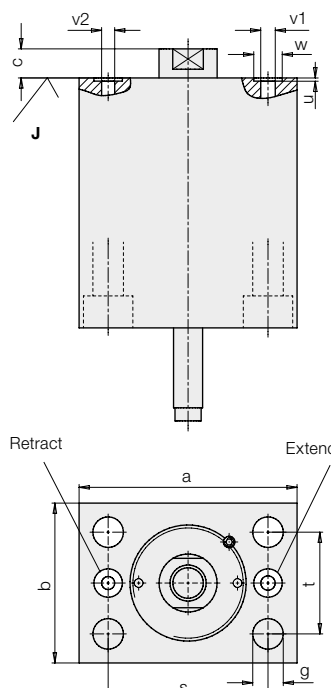
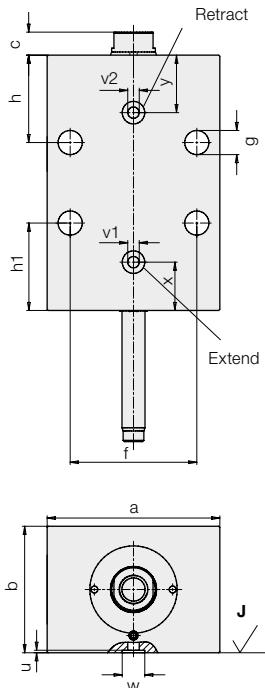
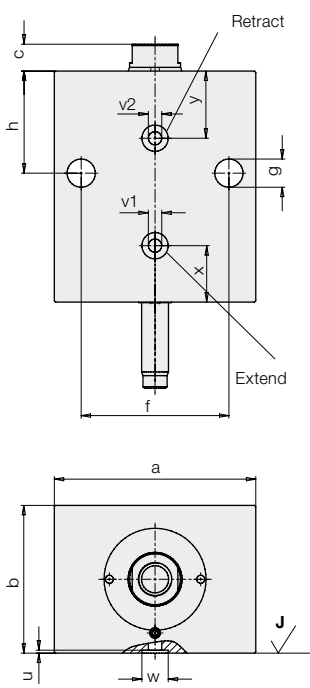

J = 0,8 $\sqrt[0,04]{100}$

Dimensions Technical data

Piston Ø D	[mm]	25	32	40	50	63	80	100	125	
Rod Ø d	[mm]	16	20	25	32	40	50	63	80	
Force to push at	100 bar	[kN]	4.1	7.2	11.8	18.9	30.4	49.5	77.8	122
	500 bar	[kN]	20.6	36.2	58.9	94.2	152	247	389	610
Force to pull at	100 bar	[kN]	2.9	4.9	7.7	11.6	18.6	30.6	47.4	72.4
	500 bar	[kN]	14.5	24.5	38.3	58	93	153	237	362
Oil volume per 10 mm stroke										
Stroke to extend	[cm ³]	4.1	7.2	11.8	18.9	30.4	49.5	77.8	122	
Stroke to retract	[cm ³]	2.9	4.9	7.7	11.6	18.6	30.6	47.4	72.4	
a	[mm]	65	75	85	100	125	160	200	230	
b	[mm]	45	55	63	75	95	120	150	180	
c	[mm]	7	10	10	10	14	14	15	16	
f	[mm]	50	55	63	76	95	120	158	180	
g	[mm]	8.5	10.5	10.5	13	17	21	25	32	
h	[mm]	33	38	40	44	50	60	64	82	
h1	[mm]	38	38	38	40	49	-	-	-	
k	[mm]	22.5	27.5	31.5	37.5	47.5	60	75	90	
m	[mm]	23	22	22	23	25	24	25	31	
n	[mm]	18	22	24	27	26	34	35	47	
o x depth of thread	[mm]	M10x15	M12x15	M16x25	M20x30	M27x40	M30x40	M42x60	M48x70	
p		G1/4	G1/4	G1/4	G1/4	G1/2	G1/2	G1/2	G1/2	
r	[mm]	-	-	4	4	4	5	6	8	
s	[mm]	50	55	63	76	95	120	158	180	
t	[mm]	30	35	40	45	65	80	108	130	
u ± 0.05	[mm]	1.1	1.1	1.1	1.1	1.5	1.5	1.5	1.5	
v1 extend	[mm]	4	5	6	6	8	8	8	8	
v2 retract	[mm]	4	4.5	4.5	6	6	8	8	8	
w +0.2	[mm]	9.8	9.8	9.8	10.8	13.8	13.8	13.8	13.8	
x	[mm]	19.5	21	21	23	24	24	25	31	
y	[mm]	21	25	27	29.5	32	39	40	47	
SW	[mm]	13	17	-	-	-	-	-	-	
Dimensions O-ring		7x1.5	7x1.5	7x1.5	8x1.5	10x2	10x2	10x2	10x2	
Part no. O-ring		3001077	3001077	3001077	3000275	3001078	3001078	3001078	3001078	
Stroke ±1	[mm]	20	25	25	25	30	32	40	40	
Total length l±1	[mm]	83	96	100	110	124	134	145	166	
l1	[mm]	45	45	45	45	45	65	65	65	
l2	[mm]	27	32	32	32	37	47	47	47	
Weight	[kg]	1.4	2.3	3.1	4.8	8.3	14.8	24.9	39.1	
Part no.										
Version with pipe thread		1543407	1544407	1545407	1546407	1547407	1548407	1549407	1550407	
Flange-type version		1543407X	1544407X	1545407X	1546407X	1547407X	1548407X	1549407X	1550407X	
Stroke ±1	[mm]	50	50	50	50	50	50	50	50	
Total length l±1	[mm]	113	121	125	135	144	152	155	176	
l1	[mm]	65	65	65	65	65	65	65	65	
l2	[mm]	57	57	57	57	57	57	57	57	
Weight	[kg]	2	2.9	4.0	6.0	9.7	16.8	26.7	41.5	
Part no.										
Version with pipe thread		1543408	1544408	1545408	1546408	1547408	1548408	1549408	1550408	
Flange-type version		1543408X	1544408X	1545408X	1546408X	1547408X	1548408X	1549408X	1550408X	

Code for part numbers for flange-type version

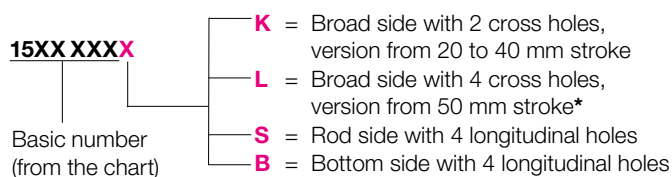

Order:

Please add the identification letters **K, L, S, B** to the part-number of the required block cylinder.

Example of ordering:

Double-acting block cylinder 1545407 with oil supply at the broad side **Part no. 1545407K**

* Sizes 1548 up to 1550408L only with 2 cross holes available.

Accessory: Position monitoring

Description

The position monitoring will be screwed on at the cylinder bottom and can also be mounted in a position rotated by 180°. Different versions are available according to the application conditions. A control cam is provided at the extended piston rod causing the activation of the proximity switches. Adjustment of the switching position is effected by displacement of the proximity switches in the lateral groove. The proximity switches are switched on in a stroke range of approx. 6 mm by means of the control cam. The minimum distance to the positions to be monitored depends on the switch type and is indicated in the chart. The position monitoring can alternatively be supplied with or without proximity sensors.

Function

Electrical acknowledgement of both end positions or also intermediate positions.

Electric circuit diagram

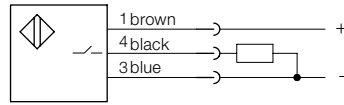

Important notes

- Position monitoring systems are not suitable for applications where coolants are used.
- Additional covers also have to be provided against swarf.



Block cylinder with position monitoring

Material of the body

Steel

Technical data/dimensions

Operating voltage UB	10 ... 30 V DC
Ripple	max. 15%
Switching function	Interlock
Basic technology	PNP
Material of housing	stainless steel
Code class as per DIN 40050	IP 67

Type A

Standard version

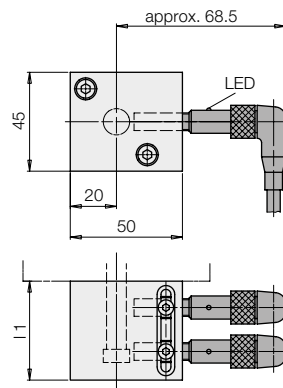

Type B

Compact version

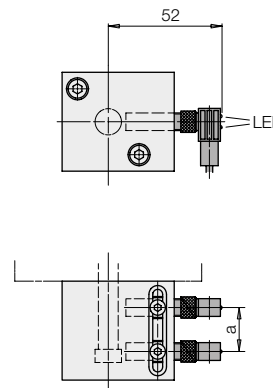

Type C

for high environmental temperature

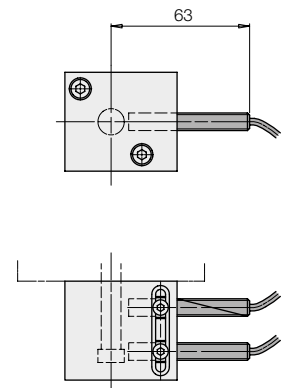

Environmental temperature TA		-25° ... +70°C	-25° ... +70°C	-25° ... +120°C
Min. distance of the switching positions	[mm]	13	8	8
Connection type		Plug	Plug	Teflon cable 3 x 0.14 mm ²
LED function display		in the switch	in the plug	No
Max. constant current	[mA]	200	100	200 – exceeding 70°:100
Nominal switch distance	[mm]	1.5	1.5	2
Short circuit proof		Yes	Yes	No
Connecting cable	[m]	5	5	3

Position monitoring with proximity switches

Piston stroke 20...30 mm	Part no.	0382300	0382301	0382302
Body length l1	[mm]	45	45	45
Fixing screws DIN 912-8.8*		M5 x 50	M5 x 50	M5 x 50
Piston stroke 32...50 mm	Part no.	0382310	0382311	0382312
Body length l1	[mm]	65	65	65
Fixing screws DIN 912-8.8*		M5 x 70	M5 x 70	M5 x 70

Accessories/ spare proximity switch

Plug with cable	Part no.	3829088	3829099	–
Proximity switch	Part no.	3829077	3829263	3829087

Position monitoring without proximity switches

Piston stroke 20...30 mm	Part no.	0382303
Piston stroke 32...50 mm	Part no.	0382313

* Included in our delivery

Required dimensions for own inductive proximity switches:

